

KMD-700M_H

MODULAR CRESCENT CUBER

Item # _____

Project: _____

Qty: _____

*AutoCad available on KCL

KMD-700M_H

10/08

Item # 13152

CUBER DIMENSIONS

W x D x H

KMD-700M_H
30 x 24^{5/8} x 28



KMD-700MAH



Air-Cooled
Shown on an optional
Lancer 30" Dispenser

KMD-700MWH

Water-Cooled

KMD-700MRH

Remote Air-Cooled

- Up to 730 lbs. of ice production per 24 hours
- Ice on beverage design
- Durable stainless steel exterior
- Individual crescent cube
- Protected by *HoshiGuard* Antimicrobial Agent 
- CycleSaver® Design 
- EverCheck® alert system 
- Stainless steel evaporator
- Removable air filters (Air-cooled model only)
- R-404A Refrigerant



Warranty

Valid in United States, Canada, Puerto Rico, & U.S. Territories. Contact factory for warranty in other countries.

Three Year - Parts & Labor on entire machine.

Five Year - Parts & Labor on: Evaporator.

Five Year - Parts on: Compressor, air-cooled condenser coil.



KMD-700M_H MODULAR CRESCENT CUBER

DIMENSIONS
W x D x H
KMD-700M_H
30 x 24^{5/8} x 28

- Air-cooled
- Water-cooled
- Remote Air-cooled

AIR-COOLED

Water Temp ° F.	50°	70°	90°	
Air Temp ° F.	70°	696	650	593
80°	661	589	536	
90°	650	539	483	

WATER-COOLED

Water Temp ° F.	50°	70°	90°	
Air Temp ° F.	70°	701	675	634
80°	681	640	597	
90°	675	611	569	

REMOTE AIR-COOLED

Water Temp ° F.	50°	70°	90°	
Air Temp ° F.	70°	730	715	655
80°	719	696	614	
90°	715	679	605	

UTILITY CONSUMPTION

Model Number	Ice Production Per Cycle		KWH per 100 LBS. 90/70	Potable Water Gal. per 100 lbs. 90/70	Condenser Water Gal. per 100 lbs. 90/70
	Lbs.	Cubes			
KMD-700MAH	9.6	624	7.5	35.5	N/A
KMD-700MWH	9.6	624	6.0	33.3	99
KMD-700MRH	9.6	624	6.3	32.1	N/A

SPECIFICATIONS

Model Number	Condenser	Amperage	Min. Circuit Ampacity	Shipping Weight
KMD-700MAH	Air-Cooled	13.5	14.3	249 lbs.
KMD-700MWH	Water-Cooled	12	12.9	249 lbs.
KMD-700MRH	Remote Air-Cooled	13	13.15	249 lbs.

ELECTRICAL & PLUMBING/KMD-700M_H

- 208-230V/60/1 (3 wire with dedicated neutral for 115V)
- 20 amp Max Fuse/HACR Breaker Size
- 1/2" OD copper or equivalent independent potable water supply
- 3/4" FPT independent drain connection
- 5/8" OD pipe



© HOSHIZAKI AMERICA, INC.

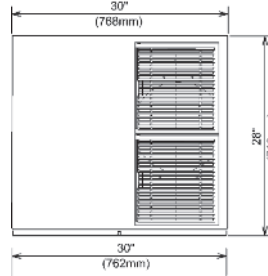

KMD-700MAH
FRONT VIEW

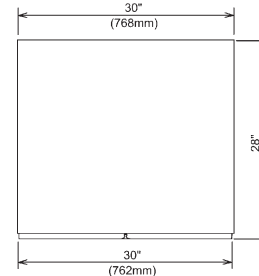

KMD-700MRH & MWH
FRONT VIEW

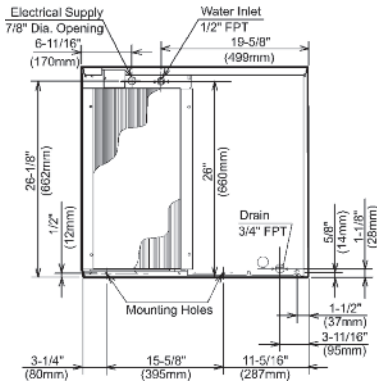

AIR-COOLED UNIT

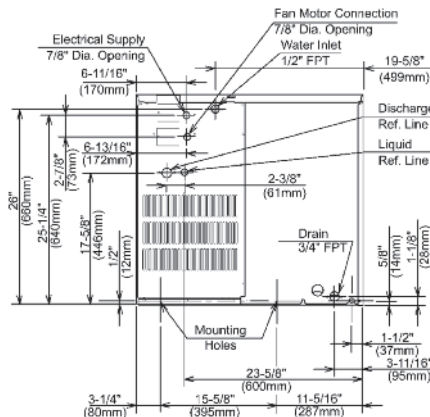

REMOTE AIR-COOLED UNIT

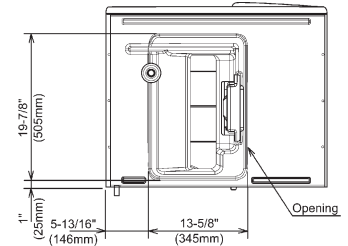

ICE DROP ZONE

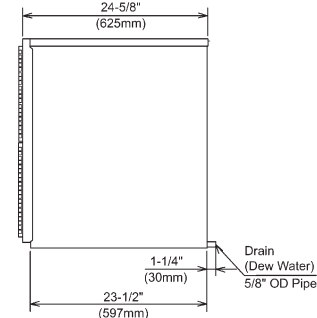

SIDE VIEW

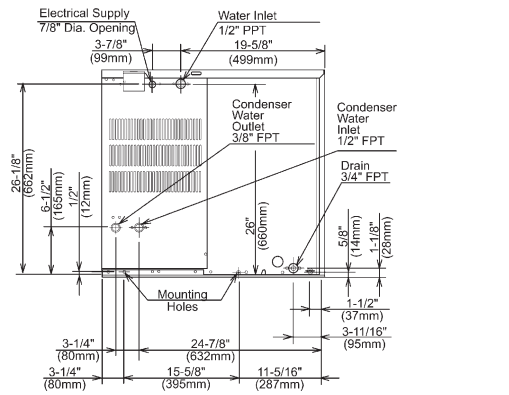

WATER-COOLED UNIT

URC-12F Remote Condenser (Sold Separately)
For Use with KMD-700MRH

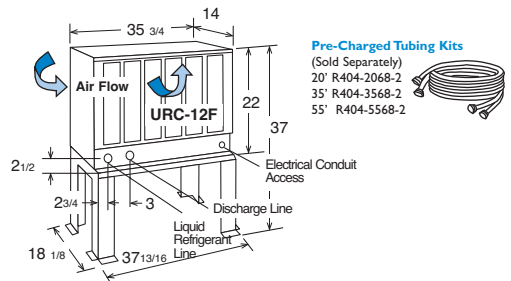

Pre-Charged Tubing Kits
(Sold Separately)
20' R404-2068-2
35' R404-3568-2
55' R404-5568-2

Voltage supply for the URC Remote Condenser is supplied from the Ice Maker. No additional circuit is required.

OPERATING LIMITS

- Ambient Temp Range 45 - 100°F
- Water Temp Range 45 - 90°F
- Water Pressure 20 - 145psig
- Voltage Range 187 - 253V

SERVICE

- Panels easily removed and all components accessible for service.
- Removable/cleanable air filters. (Air-Cooled model only)

